

## Datasheet

### Nano Motor Controller Tree

Part No: 100473



### About the product

The Nano Motor Controller Tree is a compact module with DC outputs, controlled via the Loxone Tree technology. Its configurable outputs can be used to control the speed of DC motors, or dim LED lights.

### Electrical Data

Power supply	9 ... 26VDC		
Power consumption	typ. 0.22W, max. 0.28W		
Operating mode	<b>Motor Bidirectional 1 output</b>	<b>Motor Unidirectional 2 outputs</b>	<b>Dimmer 1 output</b>
Maximum total load of outputs	2.1A continuous; 5A peak (<30s)		2.1A
PWM frequency	1kHz ... 10kHz		400Hz
Power loss at max. load	5.8W		1.7W
Current detection setting range	100mA ... 3500mA		-
Overcurrent detection setting range	100mA ... 3500mA		-
Interface	Loxone Tree: connection with Miniserver / Tree Extension		
Ambient temperature	-20 ... 50°C / -4 ... 122°F		
Humidity	max. 95% r.H. (non condensing)		

### Connections

	Connection Cables (Output)	Power Supply	Loxone Tree
Wire cross-section	1.5mm <sup>2</sup> / AWG18	0.75 ... 2.5mm <sup>2</sup> / AWG18 ... 13	0.25 ... 0.8mm <sup>2</sup> / AWG23 ... 18
Stripping length	10mm / 0.4"	5mm / 0.2"	5mm / 0.2"
cable length	150mm / 5.91"	-	-
Torque of terminal blocks	-	0.35 ... 0.4Nm / 0.26 ... 0.3 lbf ft	-
Temperature resistance	min. 80°C / 176°F for IEC, min. 75°C / 167°F for UL	-40 ... 105°C / -40 ... 221°F	-40 ... 105°C / -40 ... 221°F
Orange	-	+ VDC / GND	-
Green / White	-	-	Loxone Tree

# LOXONE

## Connection Diagram

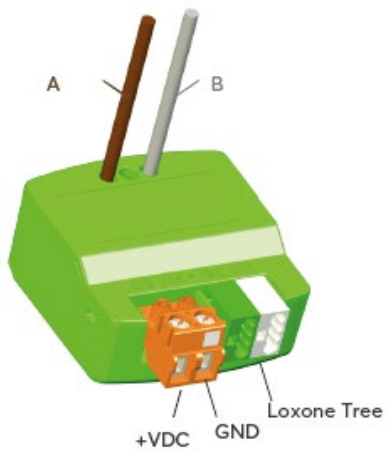

### Motor Bidirectional

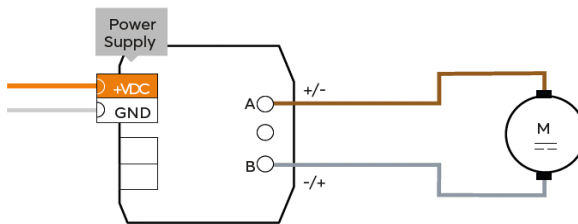

### Motor Unidirectional

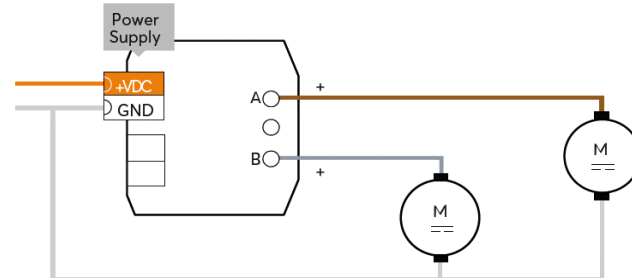

### Dimmer

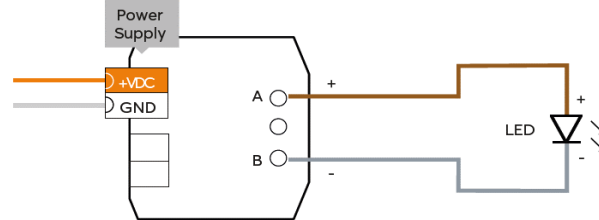

## Product Characteristics

Colours	Green: RAL6018
Finish	Matte

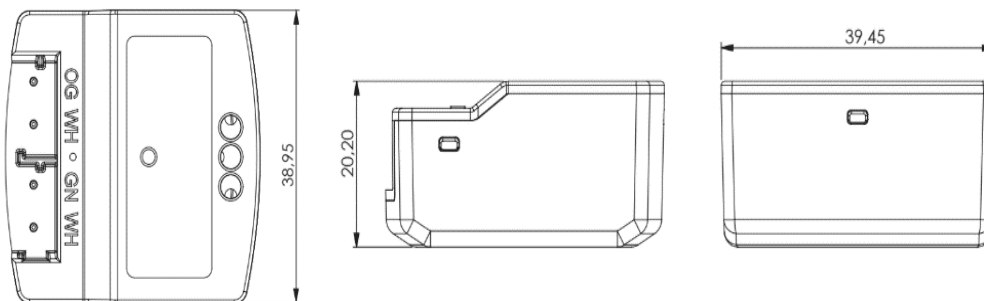

## Weight & Dimensions

Net weight	37g
Total weight	59g
Product dimensions	39.45x38.95x20.20mm / 1.55x1.53x0.80" (LxWxH)



Pack size	84x80x47mm / 3.31x3.15x1.85" (LxWxH)
-----------	--------------------------------------

## Certifications & Standards

Safety rating	IP20
	UL 60730-1 CSA E60730-1
	RECOGNIZED COMPONENT
Certifications	 

Installation must be carried out by a qualified electrician in accordance with the relevant regulations.

**Published by**  
**Loxone Electronics GmbH**  
Smart Home 1  
4154 Kollerschlag  
Austria  
Tel: +43 7287 7070-0  
loxone.com

## Datenblatt

### Nano Motor Controller Tree

Art. Nr. 100473



### Information zum Produkt

Der Nano Motor Controller Tree ist ein kompaktes Modul mit Gleichstrom Ausgängen, welches über die Loxone Tree Schnittstelle angesteuert wird. An den konfigurierbaren Ausgängen können Gleichstrom Motore in der Geschwindigkeit gesteuert werden, oder LED Leuchtmittel gedimmt werden.

### Elektrische Daten

Spannungsversorgung	9 ... 26VDC		
Leistungsaufnahme	typ. 0,22W, max. 0,28W		
Betriebsart	<b>Motor Bidirektional 1 Ausgang</b>	<b>Motor Unidirektional 2 Ausgänge</b>	<b>Dimmer 1 Ausgang</b>
Maximale Gesamtbelastung der Ausgänge	2,1A kontinuierlich; 5A Spitze (<30s)		2,1A
PWM Frequenz	1kHz ... 10kHz		400Hz
Verlustleistung bei max. Last	5.8W		1.7W
Einstellbereich Stromflusserkennung	100mA ... 3500mA		-
Einstellbereich Überstromerkennung	100mA ... 3500mA		-
Schnittstelle	Loxone Tree: connection with Miniserver / Tree Extension		
Umgebungstemperatur	-20 ... 50°C / -4 ... 122°F		
Luftfeuchtigkeit	max. 95% r.H. (nicht kondensierend)		

### Anschlüsse

	<b>Anschlusskabel (Ausgang)</b>	<b>Spannungs- versorgung</b>	<b>Loxone Tree</b>
Leiterquerschnitt	1,5mm <sup>2</sup> / AWG18	0,75 ... 2,5mm <sup>2</sup> / AWG18 ... 13	0,25 ... 0,8mm <sup>2</sup> / AWG23 ... 18
Abisolierlänge	10mm / 0.4"	5mm / 0,2"	5mm / 0,2"
Kabellänge	150mm / 5.91"	-	-
Drehmoment der Klemmen	-	0,35 ... 0,4Nm / 0,26 ... 0,3 lbf ft	-
Temperaturbeständigkeit	min. 80°C / 176°F for IEC, min. 75°C / 167°F for UL	-40 ... 105°C / -40 ... 221°F	-40 ... 105°C / -40 ... 221°F
Orange / Weiß	-	+ VDC / GND	-
Grün / Weiß	-	-	Loxone Tree

## Anschlussplan

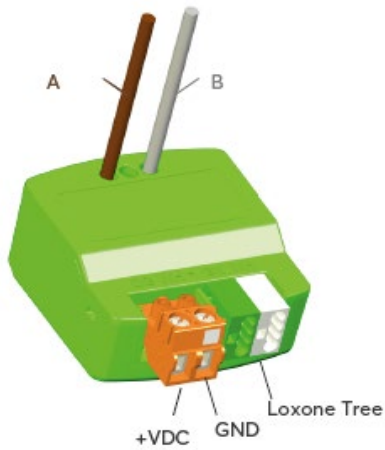

### Motor Bidirectional

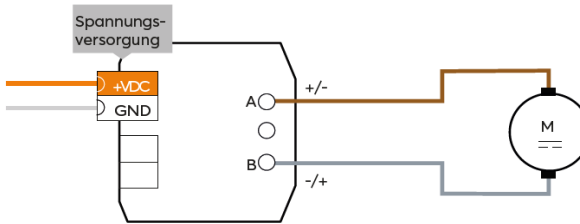

### Motor Unidirectional

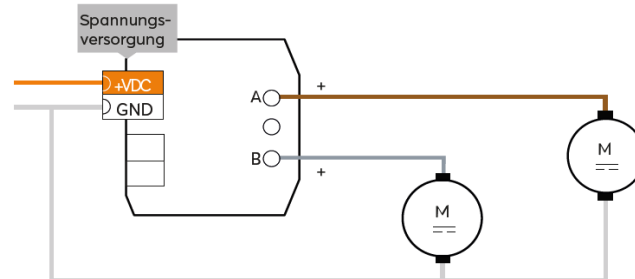

### Dimmer

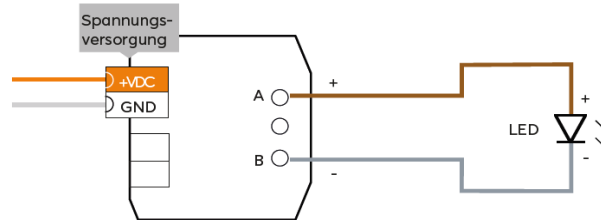

## Produkteigenschaften

Farbe	Grün RAL6018
Glanzgrad	Matt

## Gewicht & Abmessungen

Nettogewicht	37g
Bruttogewicht	59g
Produktmaße	39.45x38.95x20.20mm / 1.55x1.53x0.80" (LxWxH)

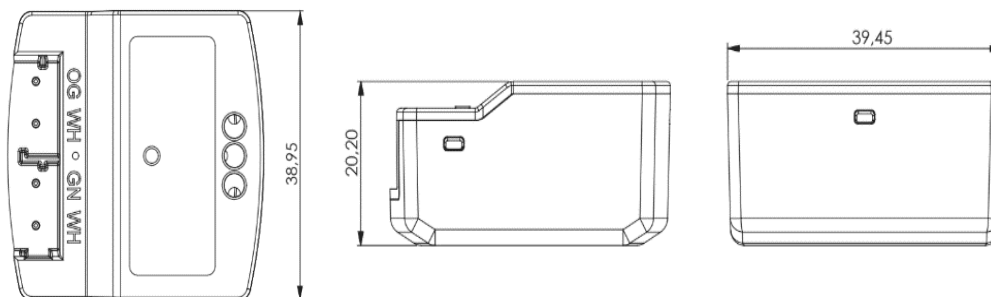

Packmaß	84x80x47mm / 3.31x3.15x1.85" (LxWxH)
---------	--------------------------------------

## Zertifizierungen & Standards

Schutzart

IP20

UL 60730-1  
CSA E60730-1

Zertifizierungen



Die Installation muss nach den einschlägigen Vorschriften durch eine Elektrofachkraft erfolgen.

**Veröffentlicht von**  
**Loxone Electronics GmbH**  
Smart Home 1  
4154 Kollerschlag  
Austria  
Tel: +43 7287 7070-0  
loxone.com