

Concrete Back Box 10

Type of construction: Concrete

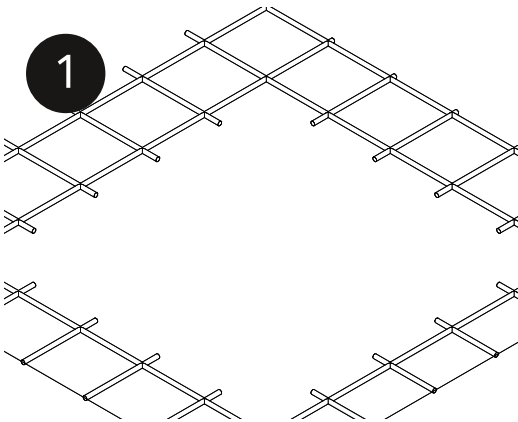

Determine desired location on the concrete formwork and cut out the steel reinforcement

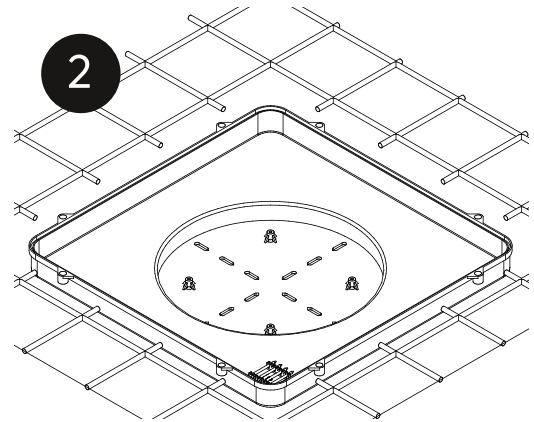

Place the lower part of the box

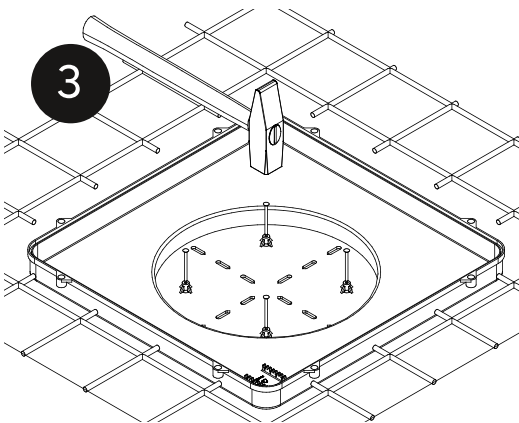

Fix the lower part of the box in place with 4x nails. (Take care that the nail head rests on the plastic dome)

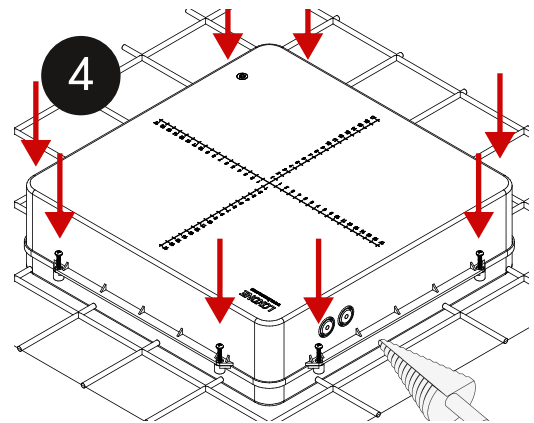

Attach the upper part of the box with the 8x screws. Use a step drill to cut out the holes for the cable conduit

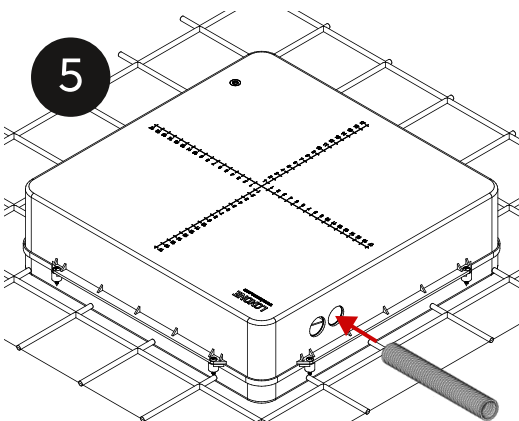

Connect the cable conduit. (Take care to avoid large gaps between back box and conduit)

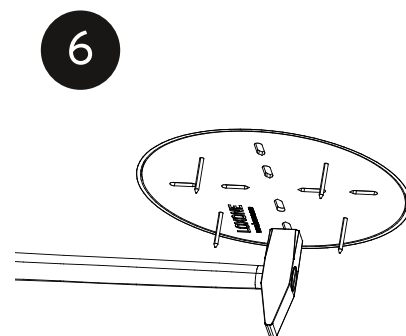

After concrete has set and the concrete formwork has been removed

- Remove any concrete that may have leaked into the box
- Remove the temporary cover
- Remove any sharp plastic part